

# IRG4IBC10UDPbF

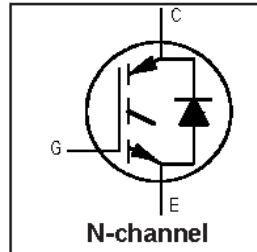
INSULATED GATE BIPOLAR TRANSISTOR WITH ULTRAFAST SOFT RECOVERY DIODE      UltraFast Co-Pack IGBT

### Features

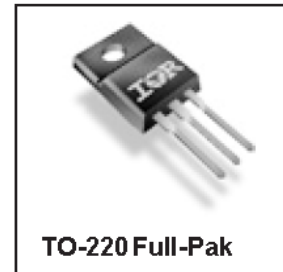
- UltraFast: Optimized for high operating up to 80 kHz in hard switching, > 200 kHz in resonant mode
- Generation 4 IGBT design provides tighter parameter distribution and higher efficiency than previous generation
- IGBT co-packaged with HEXFRED<sup>®</sup> ultrafast, ultra-soft-recovery anti-parallel diodes for use in bridge configurations
- Industry standard TO-220 Full-Pak
- Lead-Free

### Benefits

- Generation 4 IGBTs offer highest efficiencies available
- IGBTs optimized for specific application conditions
- HEXFRED<sup>®</sup> diodes optimized for performance with IGBTs  
Minimized recovery characteristics require less/no snubbing



$V_{CES} = 600V$
$V_{CE(on) typ.} = 2.15V$
@ $V_{GE} = 15V, I_C = 5.0A$
$t_{f(typ.)} = 140ns$



### Absolute Maximum Ratings

	Parameter	Max.	Units
$V_{CES}$	Collector-to-Emitter Voltage	600	V
$I_C @ T_C = 25^\circ C$	Continuous Collector Current	6.8	A
$I_C @ T_C = 100^\circ C$	Continuous Collector Current	3.9	
$I_{CM}$	Pulsed Collector Current ①	27	
$I_{LM}$	Clamped Inductive Load Current ②	27	
$I_F @ T_C = 100^\circ C$	Diode Continuous Forward Current	3.9	
$I_{FM}$	Diode Maximum Forward Current	27	
$V_{ISOL}$	RMS Isolated Voltage, Terminal to case, t=1min	2500	V
$V_{GE}$	Gate-to-Emitter Voltage	$\pm 20$	
$P_D @ T_C = 25^\circ C$	Maximum Power Dissipation	25	W
$P_D @ T_C = 100^\circ C$	Maximum Power Dissipation	10	
$T_J$	Operating Junction and	-55 to +150	°C
$T_{STG}$	Storage Temperature Range		
	Soldering Temperature, for 10 sec	300 (0.063 in. (1.6mm) from case)	
	Mounting Torque, 6-32 or M3 Screw	10 lbf•in (1.1 N•m)	

### Thermal Resistance

	Parameter	Typ.	Max.	Units
$R_{\theta JC}$	Junction-to-Case - IGBT	—	5.0	°C/W
$R_{\theta JC}$	Junction-to-Case - Diode	—	9.0	
$R_{\theta JA}$	Junction-to-Ambient, typical socket mount	—	65	
$Wt$	Weight	2.1 (0.075)	—	g (oz)

## Electrical Characteristics @ $T_J = 25^\circ\text{C}$ (unless otherwise specified)

	Parameter	Min.	Typ.	Max.	Units	Conditions
$V_{(BR)CES}$	Collector-to-Emitter Breakdown Voltage ③	600	—	—	V	$V_{GE} = 0V, I_C = 250\mu A$
$DV_{(BR)CES}/DT_J$	Temperature Coeff. of Breakdown Voltage	—	0.54	—	V/°C	$V_{GE} = 0V, I_C = 1.0mA$
$V_{CE(on)}$	Collector-to-Emitter Saturation Voltage	—	2.15	2.6	V	$I_C = 5.0A$ $V_{GE} = 15V$ See Fig. 2, 5 $I_C = 8.5A$ $I_C = 5.0A, T_J = 150^\circ\text{C}$
		—	2.61	—		
		—	2.30	—		
$V_{GE(th)}$	Gate Threshold Voltage ④	3.0	—	6.0		$V_{CE} = V_{GE}, I_C = 250\mu A$
$DV_{GE(th)}/DT_J$	Temperature Coeff. of Threshold Voltage	—	-8.7	—	mV/°C	$V_{CE} = V_{GE}, I_C = 250\mu A$
$g_{fe}$	Forward Transconductance	2.8	4.2	—	S	$V_{CE} = 100V, I_C = 5.0A$
$I_{CES}$	Zero Gate Voltage Collector Current	—	—	250	$\mu A$	$V_{GE} = 0V, V_{CE} = 600V$ $V_{GE} = 0V, V_{CE} = 600V, T_J = 150^\circ\text{C}$
		—	—	1000		
$V_{FM}$	Diode Forward Voltage Drop	—	1.5	1.8	V	$I_C = 4.0A$ See Fig. 13 $I_C = 4.0A, T_J = 125^\circ\text{C}$
		—	1.4	1.7		
$I_{GES}$	Gate-to-Emitter Leakage Current	—	—	$\pm 100$	nA	$V_{GE} = \pm 20V$

## Switching Characteristics @ $T_J = 25^\circ\text{C}$ (unless otherwise specified)

	Parameter	Min.	Typ.	Max.	Units	Conditions
$Q_g$	Total Gate Charge (turn-on)	—	15	22	nC	$I_C = 5.0A$ $V_{CC} = 400V$ See Fig. 8 $V_{GE} = 15V$
$Q_{ge}$	Gate - Emitter Charge (turn-on)	—	2.6	4.0		
$Q_{gc}$	Gate - Collector Charge (turn-on)	—	5.8	8.7		
$t_{d(on)}$	Turn-On Delay Time	—	40	—	ns	$T_J = 25^\circ\text{C}$ $I_C = 5.0A, V_{CC} = 480V$ $V_{GE} = 15V, R_G = 100W$ Energy losses include "tail" and diode reverse recovery. See Fig. 9, 10, 18
$t_r$	Rise Time	—	16	—		
$t_{d(off)}$	Turn-Off Delay Time	—	87	130		
$t_f$	Fall Time	—	140	210		
$E_{on}$	Turn-On Switching Loss	—	0.14	—		
$E_{off}$	Turn-Off Switching Loss	—	0.12	—	mJ	
$E_{ts}$	Total Switching Loss	—	0.26	0.33		
$t_{d(on)}$	Turn-On Delay Time	—	38	—	ns	$T_J = 150^\circ\text{C}$ See Fig. 11, 18 $I_C = 5.0A, V_{CC} = 480V$ $V_{GE} = 15V, R_G = 100W$ Energy losses include "tail" and diode reverse recovery.
$t_r$	Rise Time	—	18	—		
$t_{d(off)}$	Turn-Off Delay Time	—	95	—		
$t_f$	Fall Time	—	250	—		
$E_{ts}$	Total Switching Loss	—	0.45	—	mJ	
$L_E$	Internal Emitter Inductance	—	7.5	—	nH	Measured 5mm from package
$C_{ies}$	Input Capacitance	—	270	—	pF	$V_{GE} = 0V$ $V_{CC} = 30V$ See Fig. 7 $f = 1.0MHz$
$C_{oes}$	Output Capacitance	—	21	—		
$C_{res}$	Reverse Transfer Capacitance	—	3.5	—		
$t_{rr}$	Diode Reverse Recovery Time	—	28	42	ns	$T_J = 25^\circ\text{C}$ See Fig. 14 $T_J = 125^\circ\text{C}$ 14
		—	38	57		
$I_{rr}$	Diode Peak Reverse Recovery Current	—	2.9	5.2	A	$T_J = 25^\circ\text{C}$ See Fig. 15 $T_J = 125^\circ\text{C}$ 15
		—	3.7	6.7		
$Q_{rr}$	Diode Reverse Recovery Charge	—	40	60	nC	$T_J = 25^\circ\text{C}$ See Fig. 16 $T_J = 125^\circ\text{C}$ 16
		—	70	105		
$di_{(rec)M}/dt$	Diode Peak Rate of Fall of Recovery During $t_b$	—	280	—	A/ $\mu s$	$T_J = 25^\circ\text{C}$ See Fig. 17 $T_J = 125^\circ\text{C}$ 17
		—	235	—		

Details of note ① through ④ are on the last page

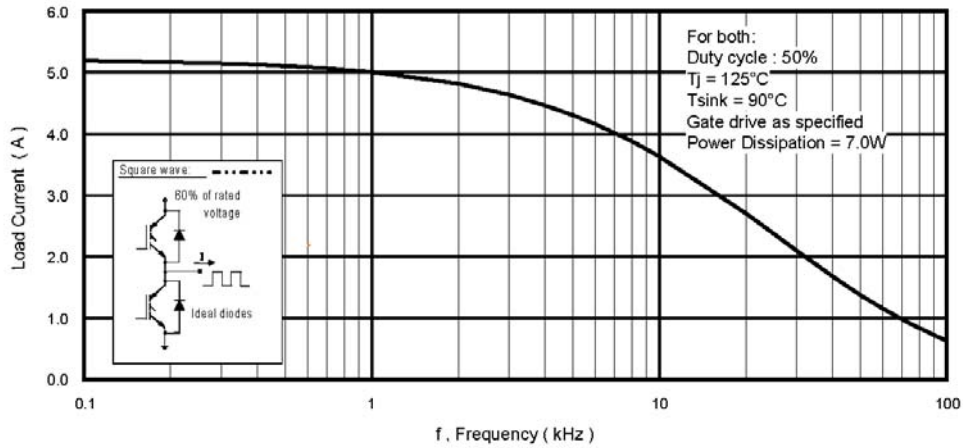


Fig. 1 - Typical Load Current vs. Frequency  
(Load Current =  $I_{\text{RMS}}$  of fundamental)

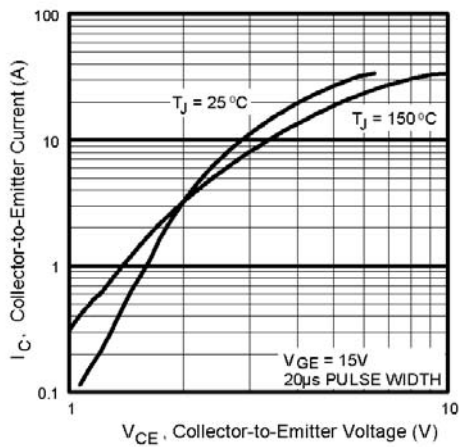


Fig. 2 - Typical Output Characteristics

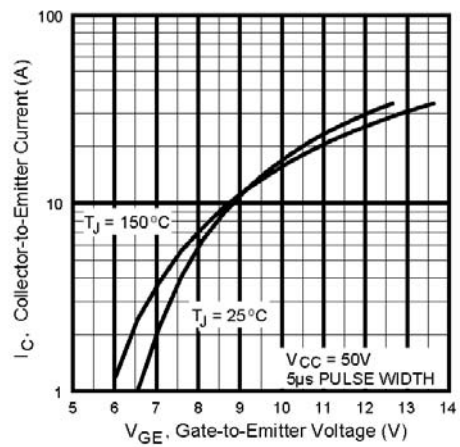
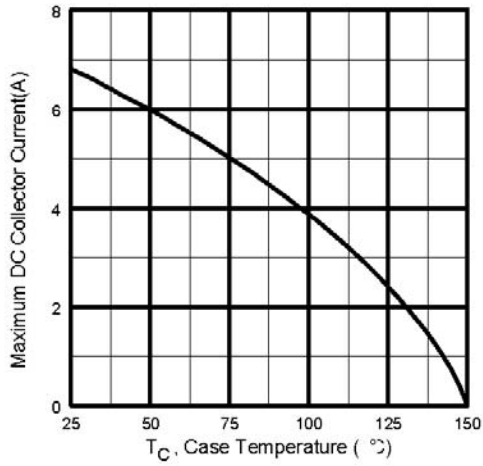
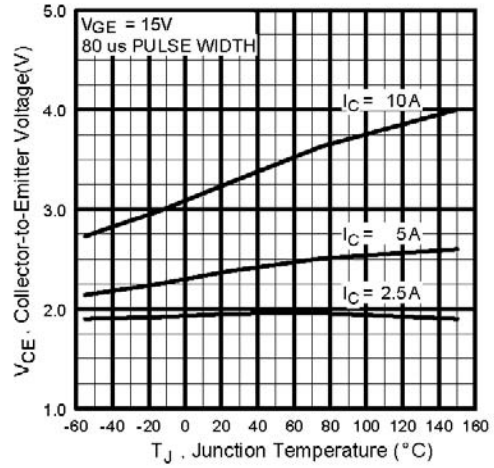


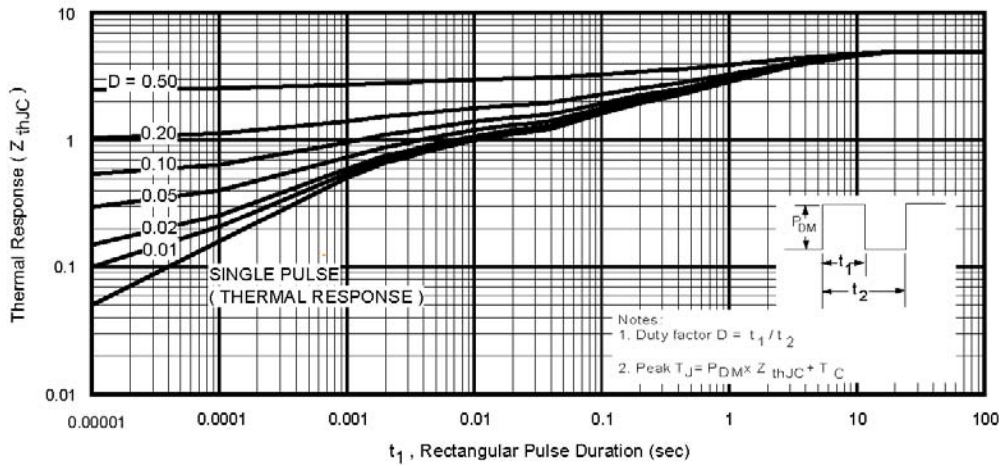
Fig. 3 - Typical Transfer Characteristics



**Fig. 4** - Maximum Collector Current vs. Case Temperature



**Fig. 5** - Typical Collector-to-Emitter Voltage vs. Junction Temperature



**Fig. 6** - Maximum Effective Transient Thermal Impedance, Junction-to-Case

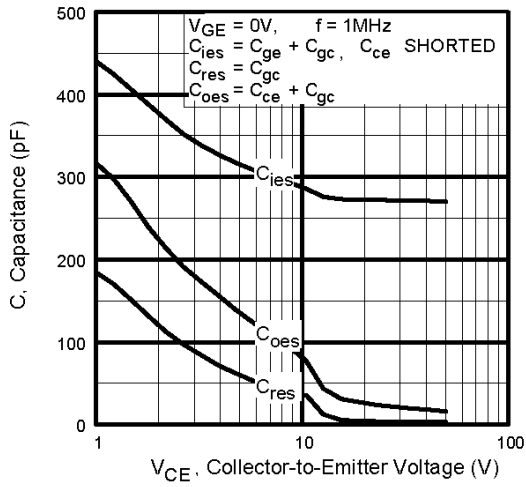


Fig. 7 - Typical Capacitance vs. Collector-to-Emitter Voltage

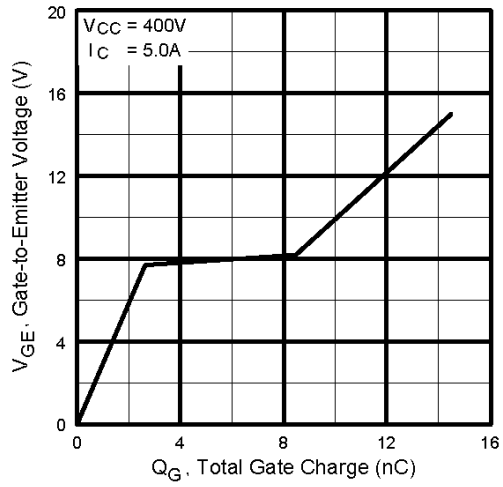


Fig. 8 - Typical Gate Charge vs. Gate-to-Emitter Voltage

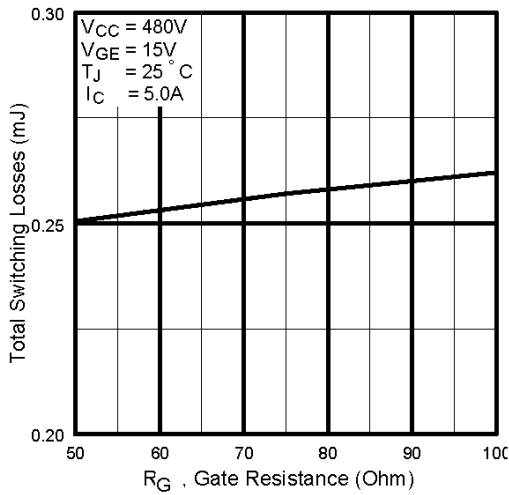


Fig. 9 - Typical Switching Losses vs. Gate Resistance

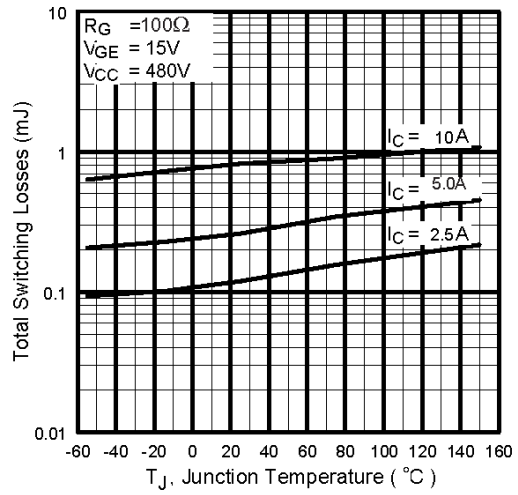
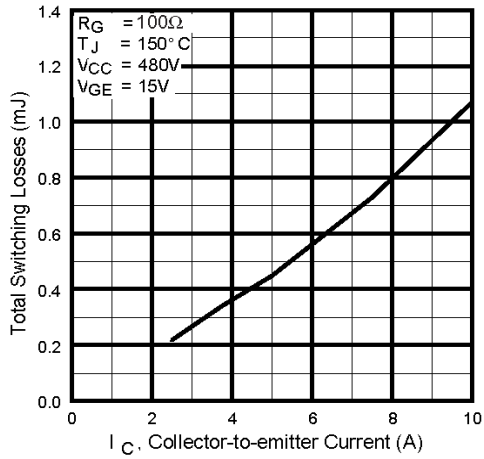
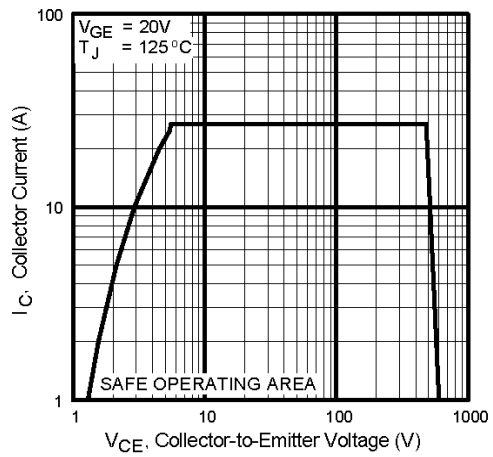


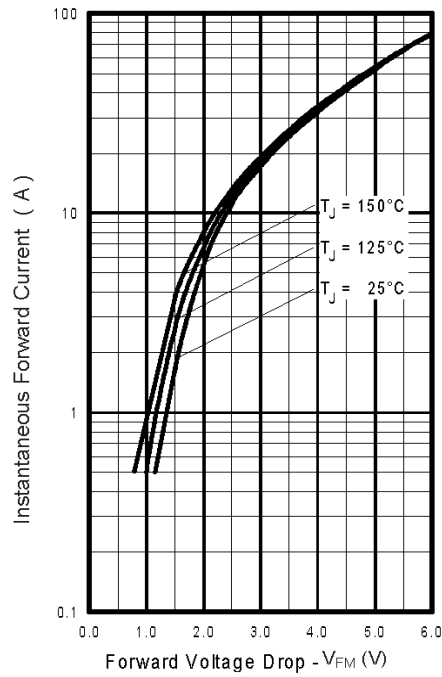
Fig. 10 - Typical Switching Losses vs. Junction Temperature



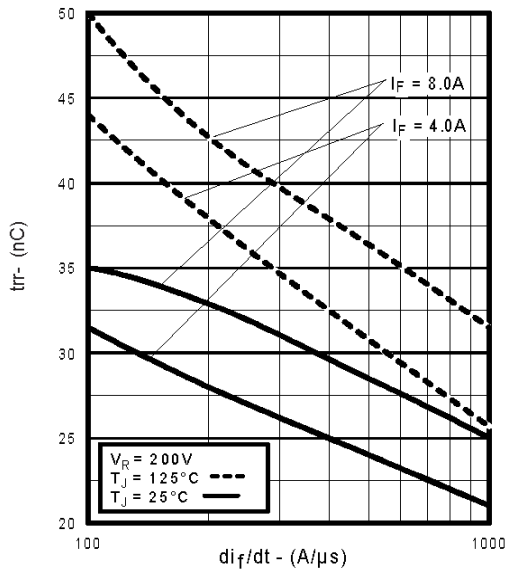
**Fig. 11** - Typical Switching Losses vs. Collector-to-Emitter Current



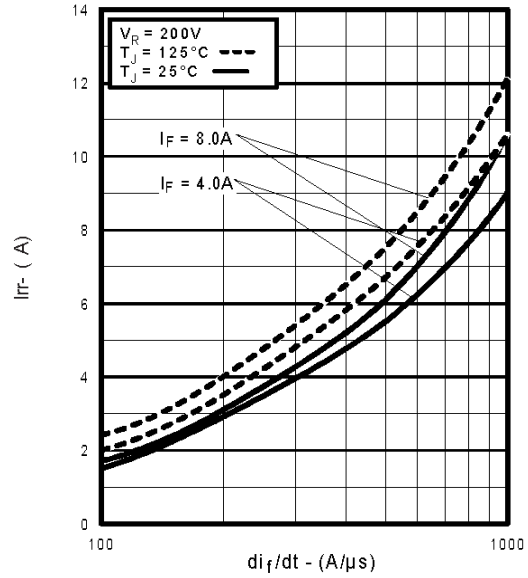
**Fig. 12** - Turn-Off SOA



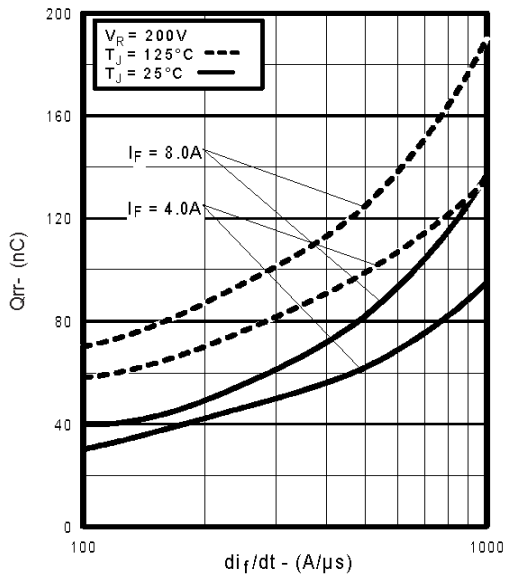
**Fig. 13** - Maximum Forward Voltage Drop vs. Instantaneous Forward Current



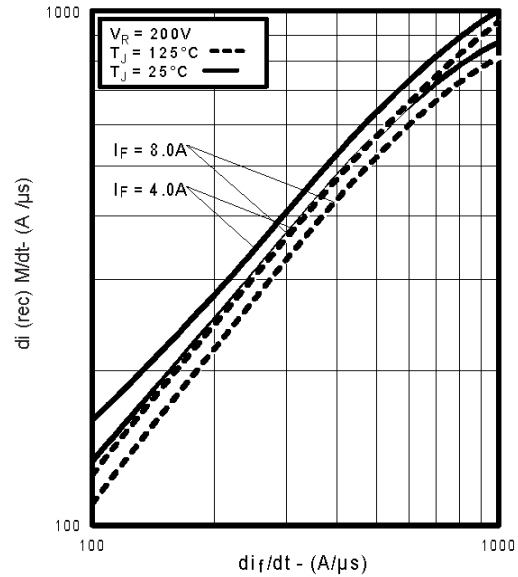
**Fig. 14** - Typical Reverse Recovery vs.  $di_f/dt$



**Fig. 15** - Typical Recovery Current vs.  $di_f/dt$

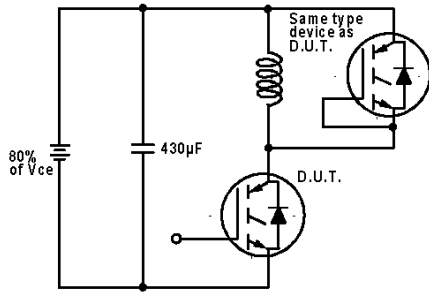


**Fig. 16** - Typical Stored Charge vs.  $di_f/dt$

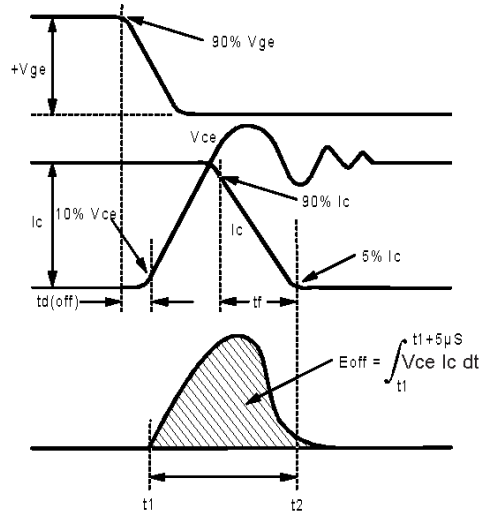


**Fig. 17** - Typical  $di_{(rec)M}/dt$  vs.  $di_f/dt$

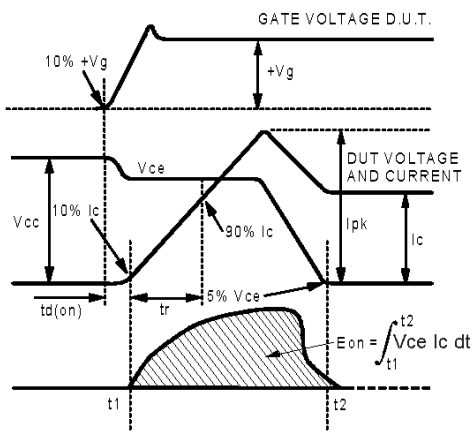
# IRG4IBC10UDPbF



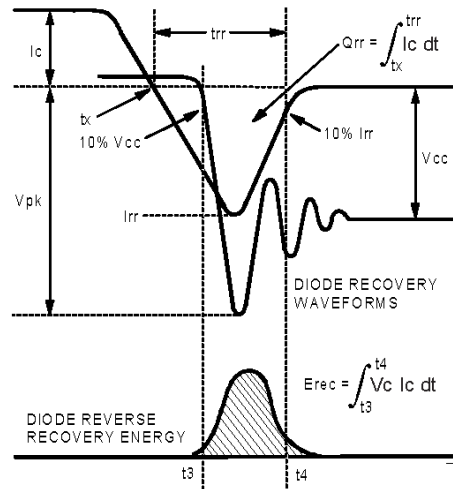
**Fig. 18a** - Test Circuit for Measurement of  $I_{LM}$ ,  $E_{on}$ ,  $E_{off}(\text{diode})$ ,  $t_{rr}$ ,  $Q_{rr}$ ,  $I_{rr}$ ,  $t_{d(on)}$ ,  $t_r$ ,  $t_{d(off)}$ ,  $t_f$



**Fig. 18b** - Test Waveforms for Circuit of Fig. 18a, Defining  $E_{off}$ ,  $t_{d(off)}$ ,  $t_f$

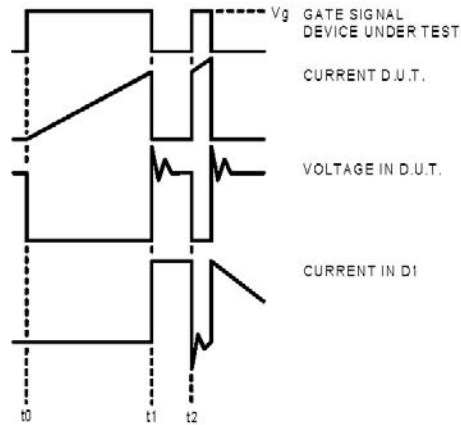


**Fig. 18c** - Test Waveforms for Circuit of Fig. 18a, Defining  $E_{on}$ ,  $t_{d(on)}$ ,  $t_r$

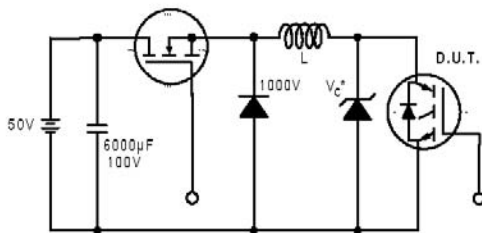


**Fig. 18d** - Test Waveforms for Circuit of Fig. 18a, Defining  $E_{rec}$ ,  $t_{rr}$ ,  $Q_{rr}$ ,  $I_{rr}$

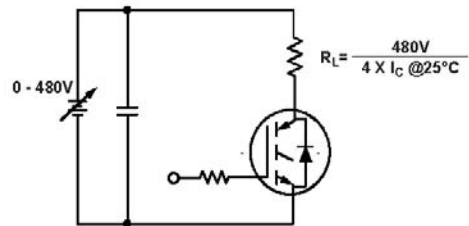




**Fig. 18e** - Macro Waveforms for Figure 18a's Test Circuit



**Fig. 19** - Clamped Inductive Load Test Circuit



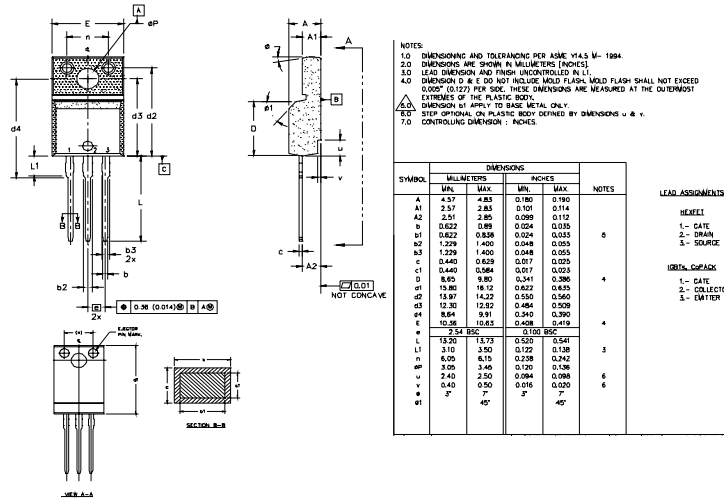
**Fig. 20** - Pulsed Collector Current Test Circuit

# IRG4IBC10UDPbF



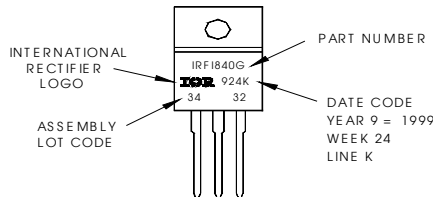
## TO-220 Full-Pak Package Outline

Dimensions are shown in millimeters (inches)



## TO-220 Full-Pak Part Marking Information

EXAMPLE: THIS IS AN IRF1840G  
 WITH ASSEMBLY  
 LOT CODE 3432  
 ASSEMBLED ON WW 24 1999  
 IN THE ASSEMBLY LINE "K"  
**Note:** "P" in assembly line  
 position indicates "Lead-Free"



## Notes

- ① Repetitive rating:  $V_{GE}=20V$ ; Pulse width limited by maximum junction temperature (figure 20)
- ②  $V_{CC}=80\%(V_{CES})$ ,  $V_{GE}=20V$ ,  $L=10\mu H$ ,  $R_G=100\Omega$  (figure 19)
- ③ Pulse width  $\leq 80\mu s$ , duty factor  $\leq 0.1\%$ .
- ④ Pulse width  $5.0\mu s$ , single shot.

Data and specifications subject to change without notice.



IR WORLD HEADQUARTERS: 233 Kansas St., El Segundo, California 90245, USA Tel: (310) 252-7105  
 TAC Fax: (310) 252-7903  
 Visit us at [www.irf.com](http://www.irf.com) for sales contact information.07/04  
[www.irf.com](http://www.irf.com)

Note: For the most current drawings please refer to the IR website at:  
<http://www.irf.com/package/>